

**CARPAS VALPARAISO**

CARPA 8X4 SEMI PRO

# CARPAS VALPARAISO

## Consideraciones

El propietario de la tienda tiene la única responsabilidad de asegurarse de que se siguen estas reglas locales y que el montaje sea el correcto.

En caso de malas condiciones climáticas, es su responsabilidad asegurarse de que las personas dentro están a salvo y que la tienda no cause daños a los demás.

Siempre se recomienda que asegure su tienda correctamente con correas de seguridad y amarras cuando coloque la estructura.

Le recomendamos que asegure la tienda, o compruebe si está cubierta por el seguro de tiendas de campaña en casa, en caso de eventos no planificados, accidentes o mal tiempo.

Estas tiendas de campaña están destinadas a **refugio temporal** y deben ser evacuadas en condiciones climáticas extremas.

siempre recomendamos eliminar la nieve de la parte superior.











**Atención:** Estas carpas están hechas para su uso en fiestas y otros arreglos festivos corporativos, y son como tales sólo para el montaje temporal a corto plazo y el desmontaje sucesivo. Tenga en cuenta que la garantía no se aplicará si se utiliza de cualquier otra manera.

## **Atención**





1. La estructura está cubierta por una carpa de aceite de fábrica, antes de instalar la carpa, retire el aceite cuidadosamente para mantener la lona limpia.
2. Tenga en cuenta que la lona debe manipularse cuidadosamente para evitar daños.
3. No fuerce en exceso la estructura, ya que puede ser dañado en el proceso.
4. Las tiendas de campaña están destinadas a refugio temporal y deben ser evacuadas en condiciones climáticas extremas.
5. Las ventanas pueden venir un poco pegajosas de fábrica, cuando se desempaquen las ventanas, por favor hágalo tan suavemente como pueda, para evitar posibles rajaduras prematuras.

Seleccione un sitio adecuado para instalar la carpa, para evitar daños en los sistemas de aspersores subterráneos, agua, gas o líneas eléctricas.



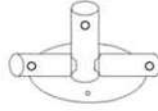
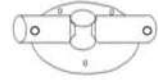

## 4m -2.3 PARTY TENT SEMI PRO

Dimention		NO	4 x6	4 x8	4 x10	4 x12	4 x14
Pipe 2188mm 50-50 with holes		1	4	6	8	10	12
Pipe 1880mm 38-38		2	15	20	25	30	35
Pipe 1880mm 38-38 with hole		3-1	2	2	2	2	2
Pipe 1880mm 38-38 with hole		3-2	2	2	2	2	2
Pipe 2030mm 50-50		4	8	10	12	14	16
Pipe 1174 mm 25-25		6	4	4	4	4	4
Pipe 2188mm 50-50 with holes and a hole		8	4	4	4	4	4
connector Three way 120°54-42		15-1 (A)	6	6	6	6	6
connector four way 120 °54-42		15-2 (B)	6	9	12	15	18
Connector three way –foot for the corners 54-42		16	2	2	2	2	2



### 4m -2.3 PARTY TENT SEMI PRO

Connector three way –foot for the corners 54-42		17	2	2	2	2	2
Connector three way –foot for the sidewalls 54-42		18	4	6	8	10	12
Connector three way –foot for the endwalls 54-42		19	2	2	2	2	2
Groundpegs		20	4	6	8	10	10
Screw hook		21	4	4	4	4	4
Groundpeg 6x180mm		22	8	10	12	14	16
Groundpeg 4x180mm		23	36	42	48	54	60

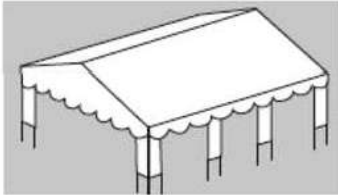
### 4m -2.3 PARTY TENT SEMI PRO

Screw M8x50		24	47	52	57	62	67
Screw M8x60		25	36	44	52	60	68
Locknuts		26	83	96	109	122	135
Long bungeeball		33	86	102	118	134	150
rope		35	4	4	4	4	2
roof		37	1	1	1	1	1

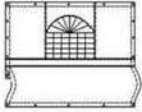
### 4m -2.3 PARTY TENT SEMI PRO

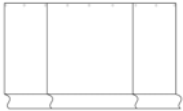
sidewall		38	6	8	10	12	14
Endwall with Large door		39	1	1	1	1	1
Endwall with Small door		40	1	1	1	1	1

## 4m -2.3 PARTY TENT SEMI PRO

I  
Select a flat surface for the tent.  
Unpack the boxes and check if all listed parts are included. Assemble the roof frame by mounting parts 15-1 & 15-2 on the pipes (Parts 2, 3-1, 3-2 & 4). Use the screws to firmly attach the parts.

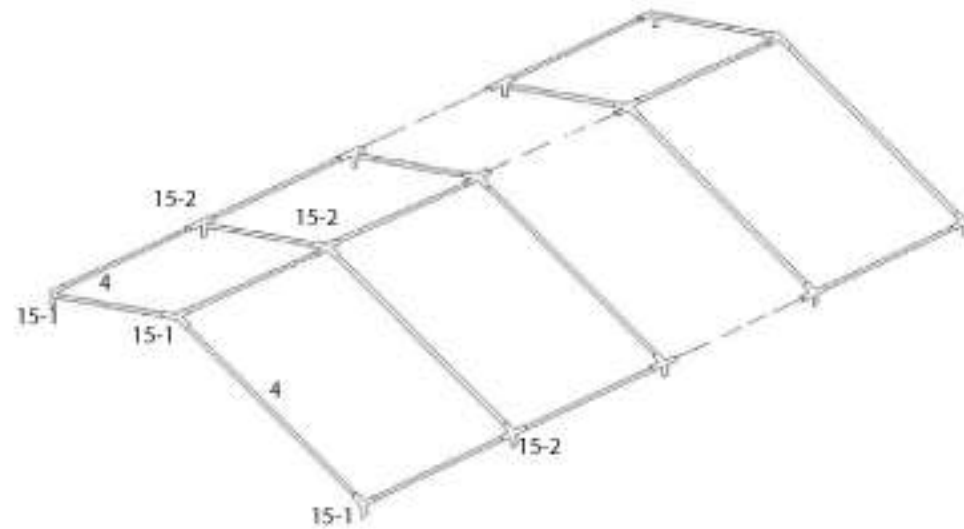
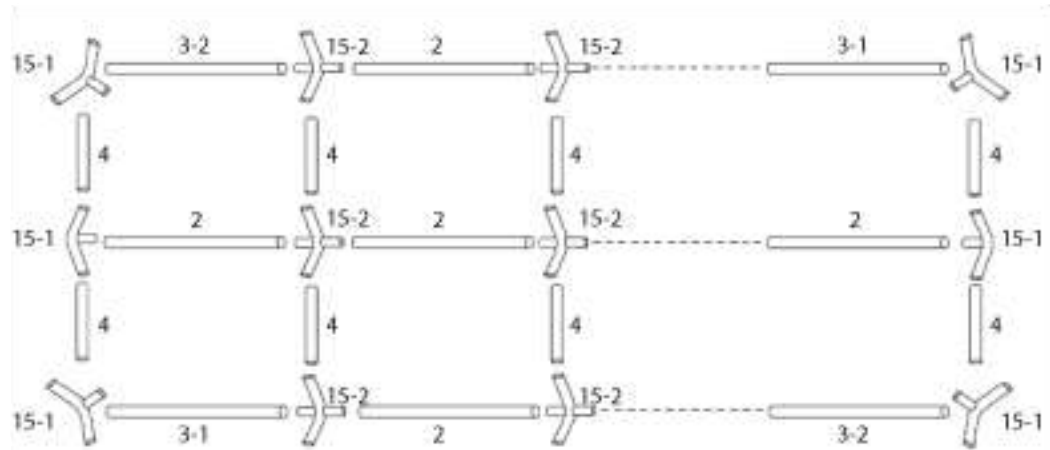



## 4m -2.3 PARTY TENT SEMI PRO

II

Lift one side of the tent frame and attach the legs(1). Attach the legs with part no. 8 to the outside in all four corners. Place the roof onto the frame and use the bungees to fasten it. Be sure not to put too much tension on the bungees in order not to make attaching the other side more difficult.

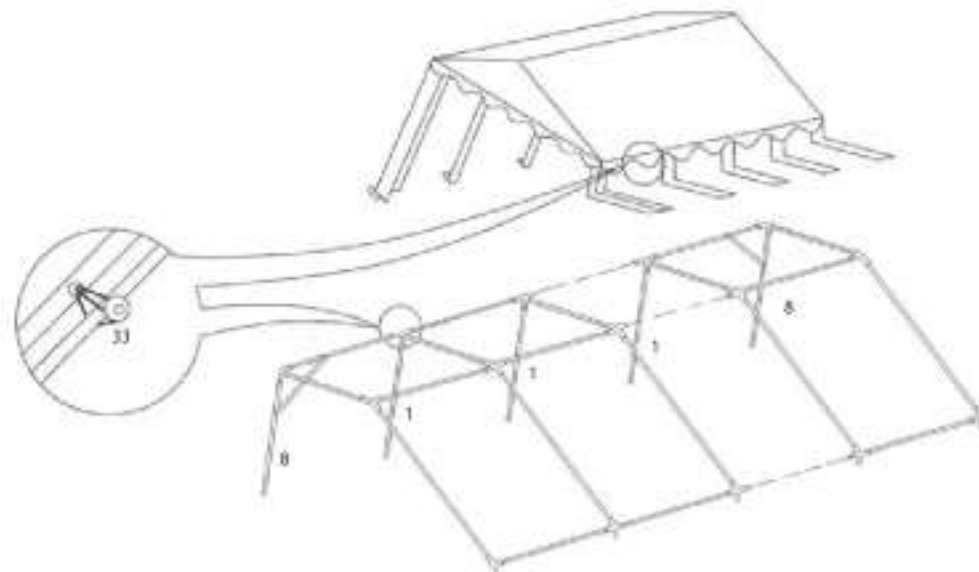

III

Attach the legs on the other side and install the feet(16,17,18,19) at the bottom. Use the long ground pegs to fasten the feet to the ground. Reinforce the side frame by attaching the diagonal pipes(6) to all four corners. Complete the bottom frame with the required pipes(2) and connectors (16,17,18,19).

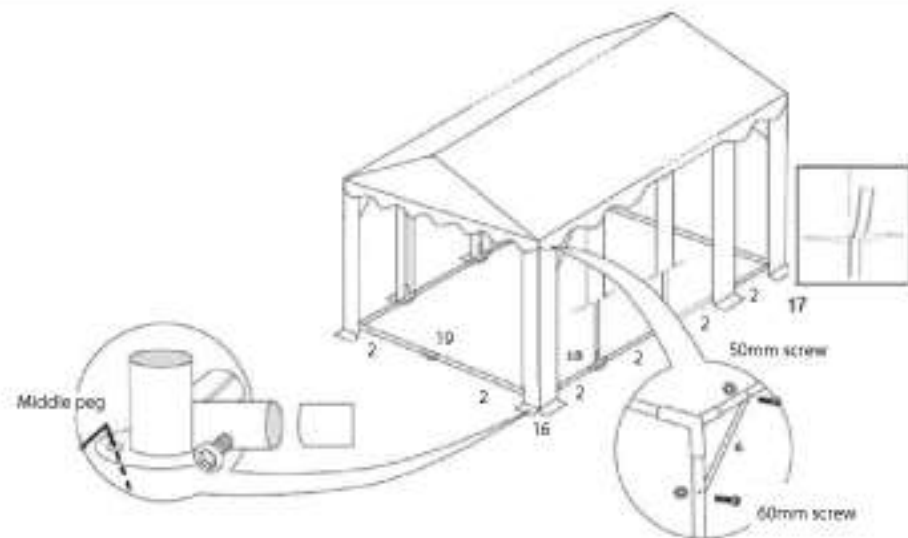

## 4m -2.3 PARTY TENT SEMI PRO

### IV

Attach the sidewalls to the frame using the bungees.

Attach the endwall directly to the roof with velcro.

Connect the leg covers to the sidewalls and endwalls with velcro as shown.

Use the short ground pegs to fasten the endwalls to the ground.

The guy rope runs from every corner of the tent and is braced to the ground using the spiral pegs.

The super pegs provide the tent with additional tension and stability

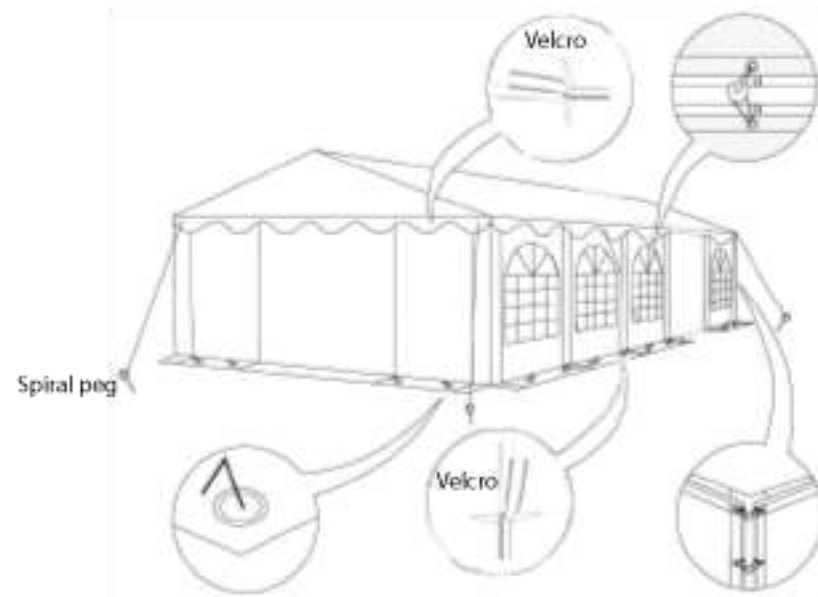

## Contacto

Para solicitar una cotización formal para organismos públicos o privados, favor remita su email o llámenos a las siguientes direcciones:

Email

[contacto@carpasvalparaiso.cl](mailto:contacto@carpasvalparaiso.cl)

WhatsApp

+569-58381809

+569-81298671

Licitaciones públicas

Post venta

Contacto:

Esaú Vásquez Carmona

Director Comercial

Teléfono:

+569-58381809

32-3581168

Contacto:

Hernán Vásquez Carmona

Director operaciones

Teléfono:

+569-58381809

32-3581168